

1550nm LD for 155M~2.5G Transmitting and 1310nm PD for less than 3.2G

Receiving(OSMW-XXTX5XXXXRA1XMX)

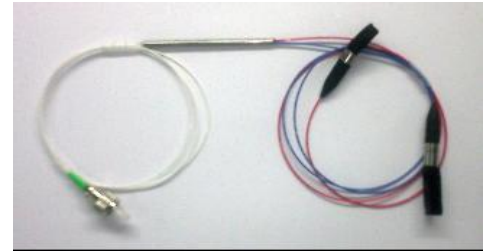

Features:

- ◆ Coaxial Package
- ◆ InGaAsP/InP MQW-DFB Laser Diode and InGaAs PIN Detector
- ◆ Low threshold, high slope efficiency and high output power
- ◆ Operating Case Temperature: -40°C to +85°C
- ◆ Single-mode fiber pigtailed with SC,FC,ST or LC connector
- ◆ High channel isolation
- ◆ Low return loss

Applications:

- ◆ Long distance digital transmission system
- ◆ Cable television system
- ◆ WDM systems

General:

OSMW-XXXT5XXXXXXX/R20XXXXX Series are WDM Series with Coaxial Laser and Detector, use InGaAsP/InP MQW chip and InGaAs PIN, which has features as follows: low noise, low distortion, excellent isolation, high reliability, high linearity and wide communication band. The laser diode and detector are mounted into a coaxial package with single mode fiber pigtail.

Absolute Maximum Ratings:

Parameter	Symbol	Ratings	Unit
Storage Temperature	Tstg	-40~+100	°C
Operating Case Temperature	Top	-40~+85	°C
Soldering Temperature (<10s)	Stemp	260	°C
Saturation Input Power	P _{overload}	10	dBm
Transmitter			
Forward Current (LD)	IFD	150	mA
Reverse Voltage (LD)	VrL	2	V
Reverse Voltage (PD)	VrP	20	V
Reverse Current (PD)	IrP	2	mA
Receiver			
Forward Current	IFD @ > 2GHz	10	mA
	IFD @ < 2GHz	1	mA
Reverse Voltage	VR	30	V

Electrical and Optical Characteristics: - Transmitter

($I_f=I_{th}+20mA$, $P_f=1mW$, SMF(9.5/125 μ m), $T_c=+25\pm 2^\circ C$, unless otherwise noted.)

Parameter	Symbol	Condition	Min.	Typ.	Max.	Unit
Threshold Current	I_{th}	CW	3	8	15	mA
Output Power (After coupled)	P_f	CW, $I_f=I_{th}+17mA$	1	2.5	3.5	mW
Operating Voltage	V_f	CW, $T_c=-40\sim+85^\circ C$	---	1.2	1.6	V
Slope Efficiency	S_e	CW, Average	0.1	0.2	0.28	mW/mA
Peak Wavelength	λ_p	CW	1540	1550	1560	nm
		CW $T_c=-40\sim+85^\circ C$	1530	---	1570	
Spectral Width	$\Delta\lambda$	CW, -20dB	---	---	1	nm
Side Mode Suppression Ratio	SMSR	CW	30	---	---	dB
Rise and Fall Time	t_r, t_f	$I_b=I_{th}$, $PL=1.5mW, 20\sim 80\%$	---	0.1	0.2	ns
Monitor Current (PD)	I_m	CW, $PL=1.5mW, VRD=1V$	0.05	0.2	---	mA
Dark Current (PD)	I_d	$VRD=10V$	---	---	0.1	μA
Capacitance (PD)	C_t	$VRD=10V, f=1MHz$	---	10	20	pF
Connector Repeatability	---	---	-1	---	1	dB
Relative Intensity Noise	---	---	---	-155	-145	dB/Hz
Optical Isolation	---	Single Stage	30	---	---	dB
	---	Dual Stage	40	---	---	
Data Rate	---	CW	---	---	2.5	G

Electrical / Optical Specifications: - Receiver

Parameter	Symbol	Test Condition	Min.	Typ.	Max.	Unit
Wavelength Range	λ	---	1100	1310	1610	nm
Active Diameter	A	---	---	75	---	μm
Responsibility	R	$VR=-5V@1310nm$	---	0.85	---	A/W
IMD2	CSO	---	---	-70	---	dB
IMD3	CTB	---	---	-80	---	dB
Dark Current	I_d	$VR = 5V$	---	0.1	1	nA
Capacitance	C_p	$VR = 5V$	---	0.4	0.8	pF
RF Bandwidth	BW	$VR = 5V$	1	---	3.2	GHz

Pin Assignment: (Transmitter) *Note1

TYPE: 1

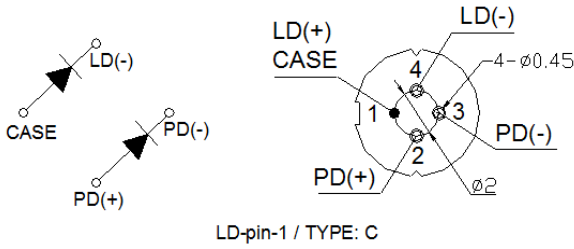

TYPE: 2

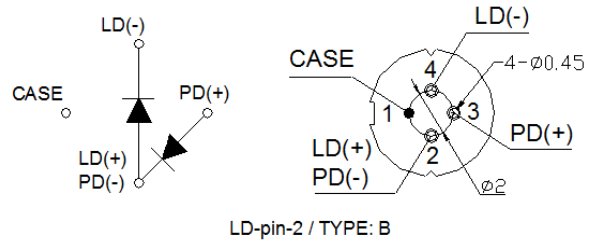

Pin Assignment: (Receiver) *Note1

TYPE: M

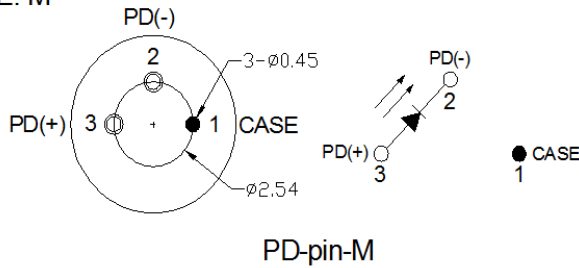

Note1: Pin assignment can be customized.

Pigtail Package Series: *Note2

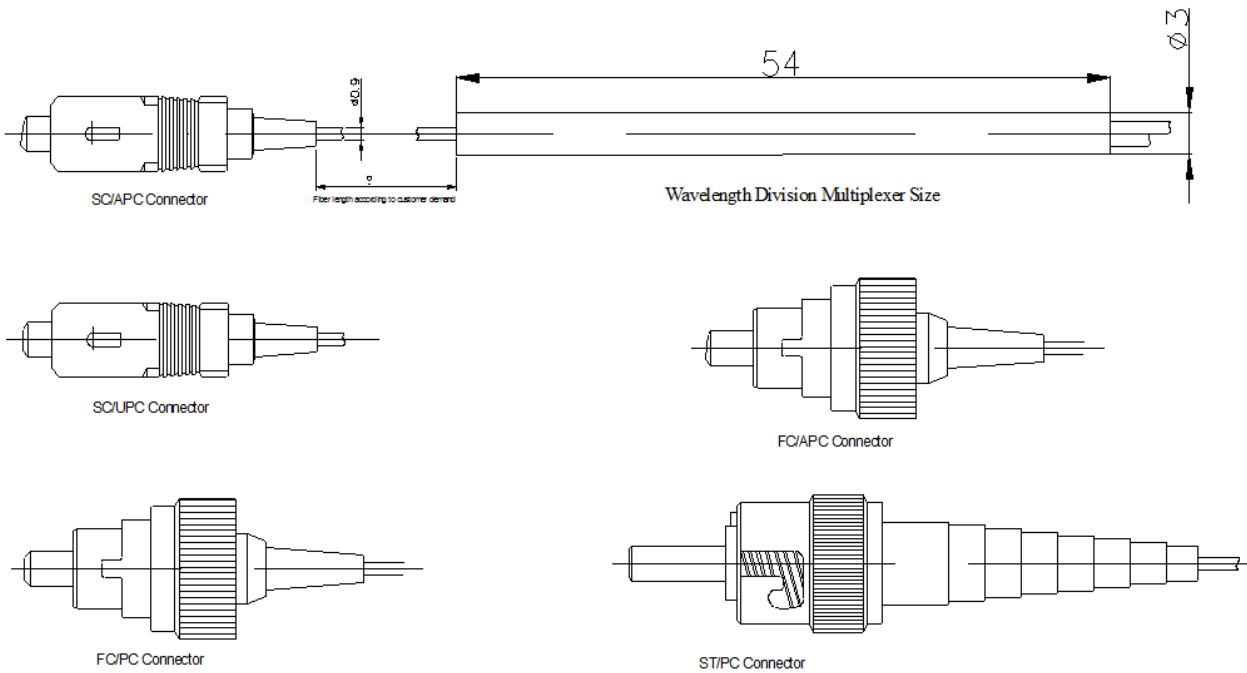

*Note2: Pigtail is standard SM fiber; the length also can be customized.

Transmitter Section: *Note3、4、5

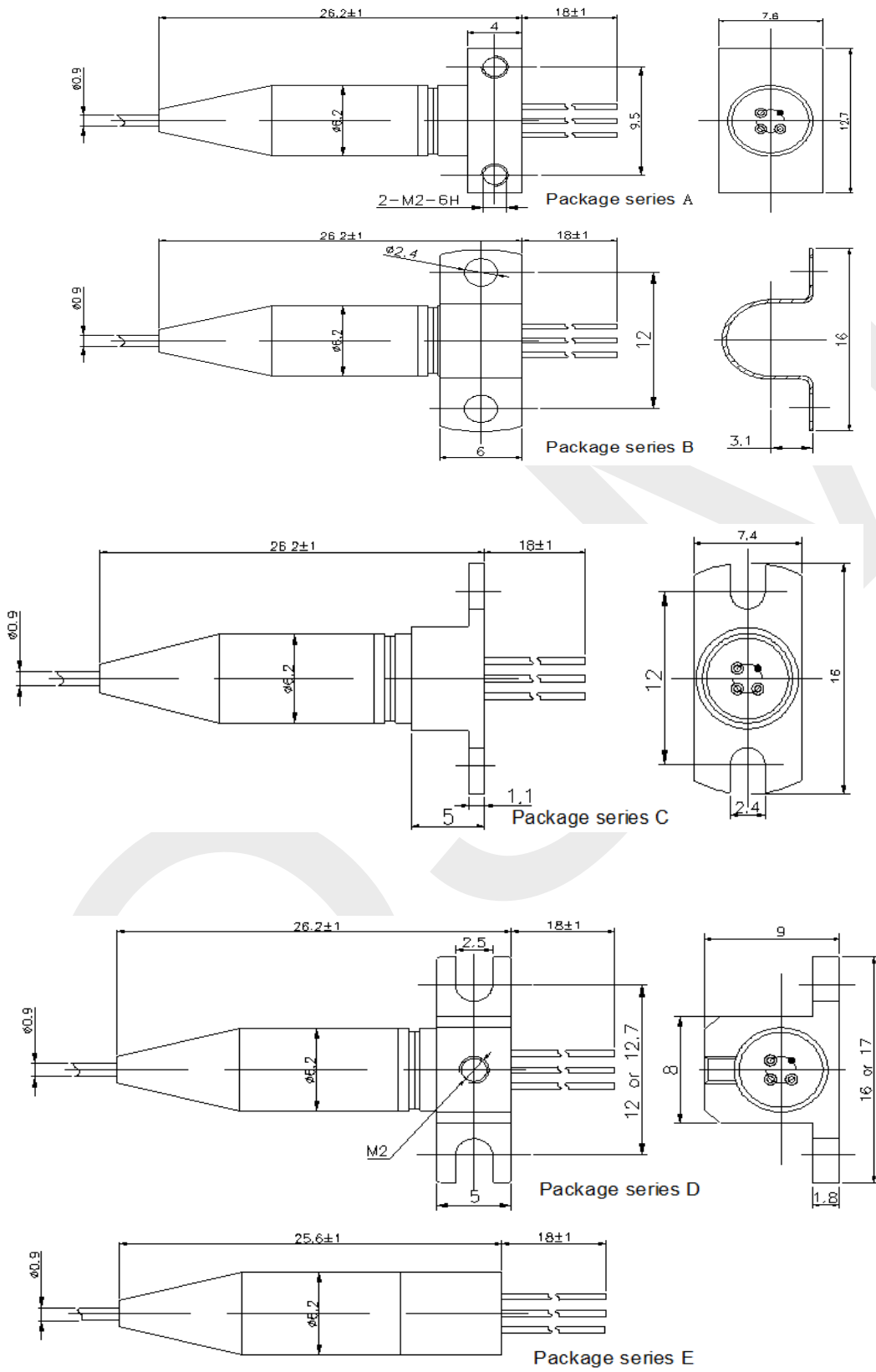

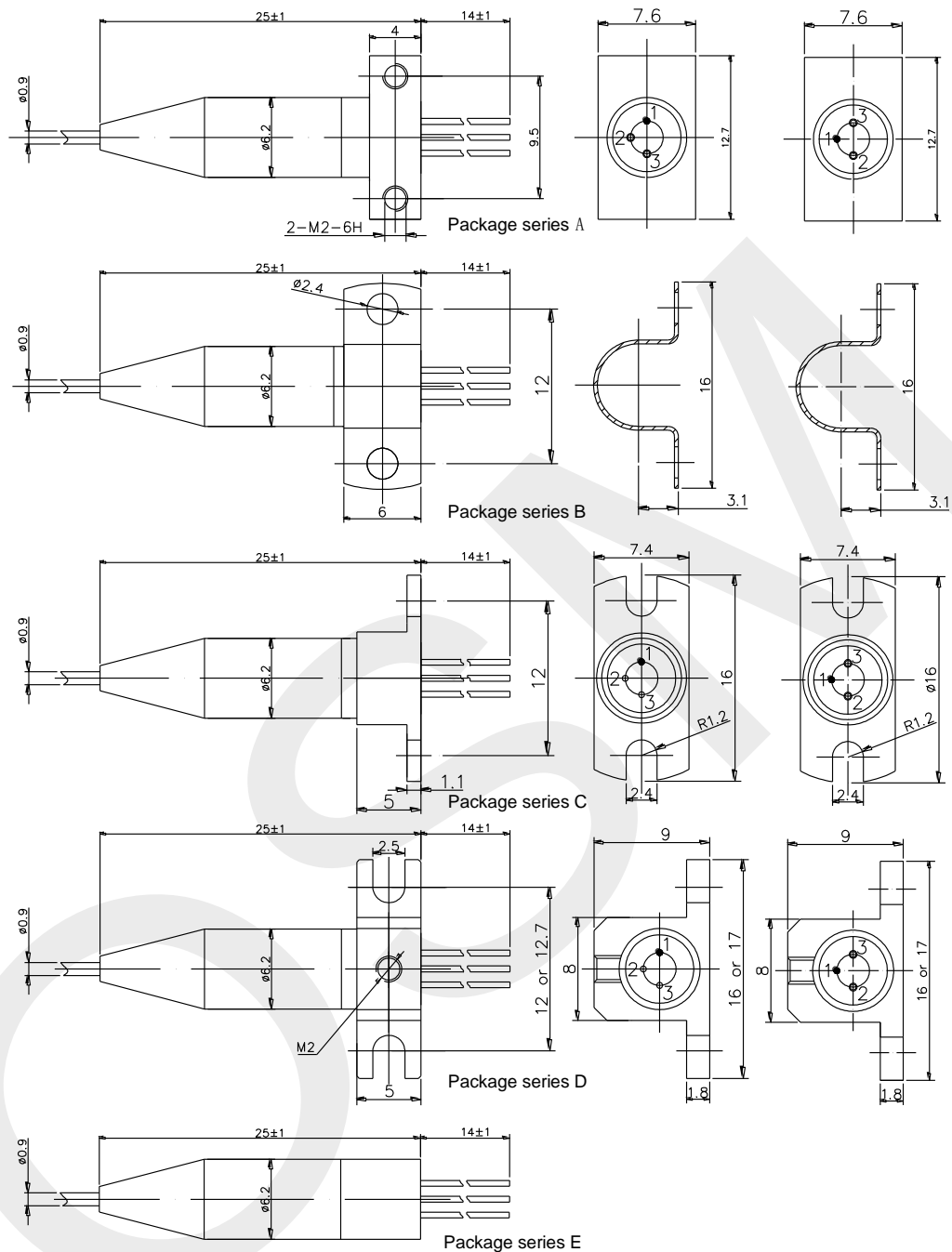
Receiver Section: *Note3、 4、 5

*Note3: PIN direction and laser mark can be customized. Pigtail is standard SM fiber; the length also can be customized.

*Note4: For the package series D, the clamping rings dimensions (A) and drill size (B) are can be selected. The following types can be available. Please designate the detailed type while ordering the package series D.

Fixed card type	A(mm)	B(mm)
D	16	12
D-S	17	12.7

*Note5: For the package series B, the fix card is fixed by customer self. For the detailed information of fix card of A, C, D package series, please refers the following graphs.

The Direction of Fix Card: (Transmitter Section)

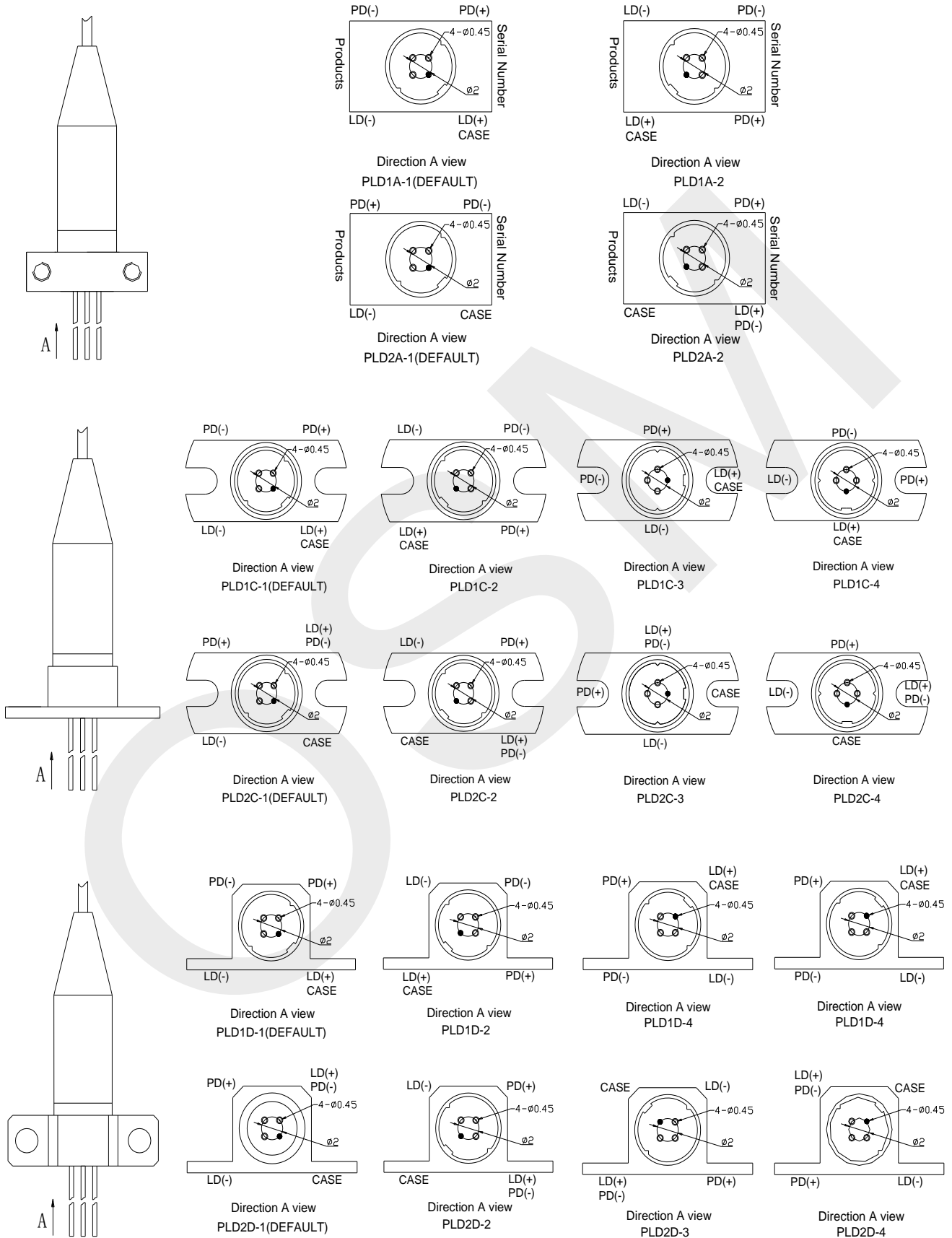

The Direction of Fix Card: (Receiver Section)

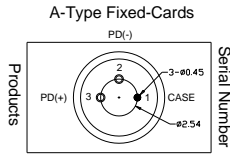
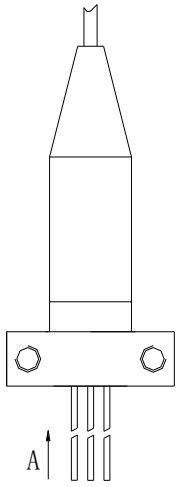

Direction A view
PPDMA-1(DEFAULT)

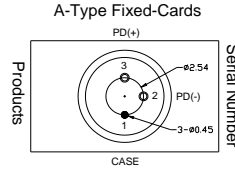

Direction A view
PPDMA-2

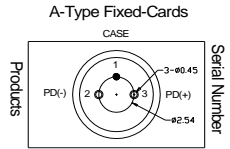

Direction A view
PPDTA-1(DEFAULT)

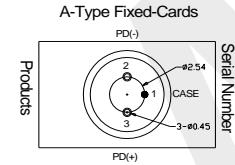

Direction A view
PPDTA-2

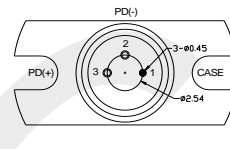
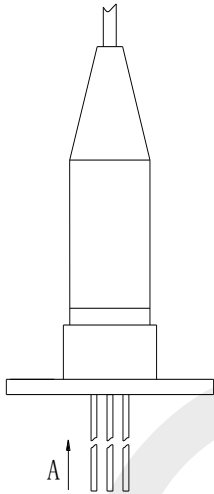

Direction A view
PPDMC-1(DEFAULT)

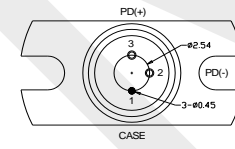

Direction A view
PPDMC-2

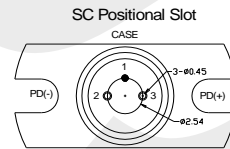

Direction A view
PPDTC-1(DEFAULT)

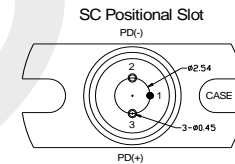

Direction A view
PPDTC-2

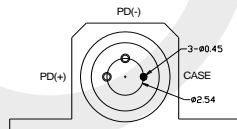
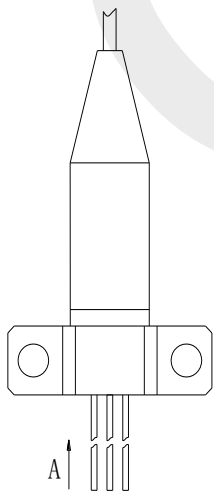

Direction A view
PPMDM-1(DEFAULT)

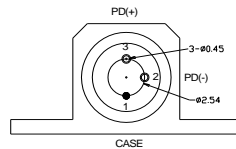

Direction A view
PPMDM-2

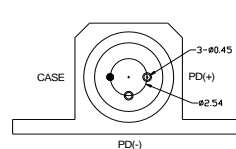

Direction A view
PPMDM-3

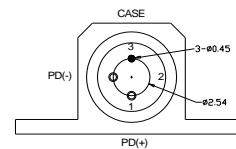

Direction A view
PPMDM-4

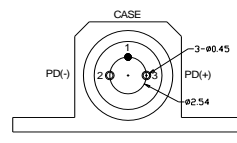

Direction A view
PPDTD-1(DEFAULT)

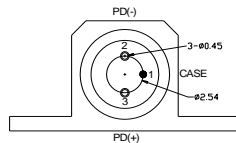

Direction A view
PPDTD-2

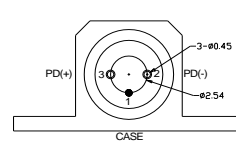

Direction A view
PPDTD-3

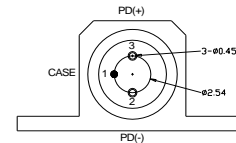

Direction A view
PPDTD-4

Nomenclature:

OSMW - □ □ T □ □ □ □ □ □ R □ □ □ □ □
 A B C D E F G H I J K L M

Code	Parameter	Detailed Description			
A	Package Series	A	B	C	D E
B	Connector	F=FC/PC	S=SC/PC	T=ST/PC	L=LC/PC
		M=MU/PC	FA=FC/APC	SA=SC/APC	N=None
T=Transmitter Section					
C	LD Type	F=FP LD		D=DFB LD	
D	Wavelength	5=1550nm			
E	Data Rate	1=1.25G		2=2.5G	
F	Power	1=0.3-0.7mW	2=0.8-1.8mW	3=1.8-2.8mW	4=2.8-3.5mW
G	Pin Type	1=LD-pin-1		2=LD-pin-2	
H	Isolator	None	G=with I	G2=with II	
R=Receiver Section					
I	Wavelength	A=1310nm			
J	Explore Area	1=75μm			
K	RF Bandwidth	0≤2GHz	1≤2.5GHz	2≤3.2GHz	
L	Pin Type	M=PD-pin-M			
M	Fiber Type	Blank=0.9mm	2=2.0mm	3=3.0mm	

Precaution:

- (1) The modules should be handled in the same manner as ordinary semiconductor devices to prevent the electro-static damages. For safe keeping and carrying, the modules should be packaged with ESD proof material. To assemble the modules on PCB, the workbench, the soldering iron and the human body should be grounded.
- (2) Please pay special attention to the atmosphere condition because the dew on the module may cause some electrical damages.
- (3) Under such a strong vibration environment as in automobile, the performance and reliability are not guaranteed.

Notice:

OSM reserves the right to make changes or discontinue any product or service identified in this publication, without notice, in order to improve design and/or performance. Applications that are described herein for any of the products are for illustrative purposes only. OSM makes no representation or warranty that such applications will be suitable for the specified use without further testing or modification.